

Synchronizing chaotic systems using filtered signals

T. L. Carroll

U.S. Naval Research Laboratory, Washington, D.C. 20375

(Received 28 January 1994)

The concept of the synchronizing of cascaded chaotic systems may be extended to cases where the driving signal has been altered by a filter, and reconstructed at the response system. Certain components are subtracted from the driving signal at the transmitter, and added back in at the receiver in a process using a feedback loop at the receiver. The drive and response systems are not identical for this experiment, although they are effectively identical when they are synchronized. This type of synchronization is demonstrated in both numerical simulations and circuit experiments.

PACS number(s): 05.45.+b

I. INTRODUCTION

It has been shown in recent work that a subsystem of a chaotic system may be synchronized to the full chaotic system by driving it with the proper signal from the full system [1–8]. Others have shown how this work may be applied in simple communications systems [9–12] or nonautonomous (periodically forced) chaotic systems [13].

The general idea of chaotic synchronization is to reproduce a signal or signals from a chaotic system by reproducing a part of the chaotic system and driving it with a signal from the original chaotic system [1,2]. Under conditions described below, the signals in the reproduced part (or subsystem) will synchronize with the signals in the original chaotic system. It is also possible to cascade subsystems of a chaotic system so that the original driving signal is reproduced [4,11,14,15]. In effect, the cascaded response system is a kind of nonlinear filter, if the proper chaotic signal is present, it is reproduced, while if any other signal is used to drive the cascaded response system, it is altered.

There has been much speculation on possible applications for synchronized chaotic systems. The most likely field for using synchronized chaos seems to be communications [11,12,16–19]. There are several ideas for applying synchronized chaos to communications systems, most of which use the chaotic signal to mask another signal or use the chaotic signal as a carrier and vary some part of the sending system to encode a signal onto the chaotic carrier.

This present work was motivated by questions that might be asked when using chaos for communications. In communications, there are often requirements placed on the frequency spectrum of a carrier signal, such as having a limited bandwidth or having no large peaks at certain frequencies. This requires the use of filters to alter the carrier signal. This conflicts with one of the basic properties of synchronized chaotic circuits; if the carrier signal is not exactly the same as the correct chaotic signal, the response circuit will not synchronize with the drive circuit. In the current work, it is shown that it is possible to alter the carrier signal in certain ways and

then reverse this alteration at the response circuit. This result also shows that it is possible to synchronize chaotic circuits that are not identical.

While the work described below is applicable to autonomous or nonautonomous chaotic systems, it is demonstrated here in a nonautonomous chaotic system. One advantage of synchronizing nonautonomous chaotic systems is that the periodic forcing terms for the two chaotic systems may be synchronized even when a large amount of noise or chaos is added to the driving signal. A disadvantage of nonautonomous systems for communications is that the power spectrum of the driving signal contains large peaks at the driving frequency and its harmonics. These peaks may be removed by filters, but this leads to a more general problem of reconstructing the driving signal at the receiver. With the approach described here, the problem becomes one of synchronizing two chaotic systems that are effectively identical only when they are synchronized; when they are not synchronized, they are not identical. Pyragas has shown a different system [20], using unfiltered chaotic signals, where the drive and response systems are effectively identical only when they are synchronized.

II. THEORY OF SYNCHRONIZATION

The theory of the synchronization of chaotic systems is described in detail elsewhere [2], so only a brief description is included here. We begin with a dynamical system that may be described by the ordinary differential equation

$$\dot{u}(t) = f(u) . \quad (1)$$

The system is then divided into two subsystems, $u = (v, w)$;

$$\begin{aligned} \dot{v} &= g(v, w) , \\ \dot{w} &= h(v, w) , \end{aligned} \quad (2)$$

where $v = (u_1, \dots, u_m)$, $g = (f_1(u), \dots, f_m(u))$, $w = (u_{m+1}, \dots, u_n)$, and $h = (f_{m+1}(u), \dots, f_n(u))$. The division is truly arbitrary since the reordering of the

u_i variables before assigning them to v , w , g , and h is allowed.

A first response system may be created by duplicating a new subsystem w' identical to the w system, substituting the set of variables v for the corresponding v' in the function h , and augmenting Eqs. (2) with this new system, giving

$$\begin{aligned}\dot{v} &= g(v, w), \\ \dot{w} &= h(v, w), \\ \dot{w}' &= h(v, w').\end{aligned}\quad (3)$$

If all the Lyapunov exponents of the w' system (as it is driven) are less than zero, then $w' - w \rightarrow 0$ as $t \rightarrow \infty$.

It is possible to take this system further. One may also reproduce the v subsystem and drive it with the w' variable [4], giving

$$\begin{aligned}\dot{v} &= g(v, w), \\ \dot{w} &= h(v, w), \\ \dot{w}' &= h(v, w'), \\ \dot{v}'' &= g(v'', w').\end{aligned}\quad (4)$$

If all the Lyapunov exponents of the w', v'' subsystem are less than 0, then $v'' \rightarrow v$ as $t \rightarrow \infty$. The example of Eq. (4) is referred to as cascaded synchronization.

III. NONAUTONOMOUS SYNCHRONIZATION

Although most of what will be said here applies to autonomous cascaded synchronized chaotic systems, the original motivation for this work involved nonautonomous systems, so a nonautonomous circuit will be used for the demonstrations here. The nonautonomous circuits used here are described in [13], and may be described by the equations

$$\frac{dx}{dt} = \beta(y - z), \quad (5)$$

$$\frac{dy}{dt} = \beta[-\Gamma_y y - g(x) + \alpha \cos(\omega t) + A], \quad (6)$$

$$\frac{dz}{dt} = \beta[f(x) - \Gamma_z z], \quad (7)$$

$$g(x) = -3.8 + \frac{1}{2}(|x + 2.6| + |x - 2.6| + |x + 1.2| + |x - 1.2|), \quad (8)$$

$$f(x) = \frac{1}{2}x + |x - 1| - |x + 1|, \quad (9)$$

where $g(x)$ and $f(x)$ are piecewise linear functions. The constants were $\alpha = 1.9$, $\Gamma_y = 0.2$, $\Gamma_z = 0.1$, $A = 0$, the time factor β is 10^4 s^{-1} , and the frequency ω is $2\pi f_d$, where the forcing frequency f_d is 780 Hz. The circuit for $g(x)$ was shown in [21], while the circuit for $f(x)$ is quite similar. Both $g(x)$ and $f(x)$ are based on diode function generators [22,23]. The response system is

$$\frac{dz'}{dt} = \beta[f(x) - \Gamma_z z'], \quad (10)$$

$$\frac{dx''}{dt} = \beta(y'' - z'), \quad (11)$$

$$\frac{dy''}{dt} = \beta[-\Gamma_y y'' - g(x'') + \alpha \cos(\omega_r t + \phi_r) + A''], \quad (12)$$

with the x signal used as a drive. The parameter ϕ_r is the difference in phase between the sinusoidal forcing in the response and the drive.

As written here, the nonautonomous systems will not synchronize unless the phase difference ϕ_r is zero. Reference [13] shows how a phase detection technique may be used with the chaotic driving signal to correct the phase ϕ_r of the response circuit, bringing the two circuits into synchronization.

Figure 1 is a plot of y versus x from the circuit of Eqs. (5)–(9). Figure 2 is a plot of y versus x from Eqs. (5)–(9). The Lyapunov exponents for the drive system, calculated from Eqs. (5)–(9) by the method of Eckmann and Ruelle [24], were 284, -1433 , and -1854 s^{-1} . If the sinusoidal forcing term were included, there would also be a zero exponent, corresponding to changes in phase in the forcing term. The sinusoidal forcing term is treated as a parameter in this calculation, so its 0 exponent does not show up here. The Lyapunov exponents for the response system [calculated from Eqs. (10)–(12)] were -780 , -1002 , and -1220 s^{-1} . Once again, the sinusoidal forcing was treated as a parameter, so the zero exponent does not show up here. The negative exponents show that if the parameter ϕ_r is zero, the response circuit described by Eqs. (10)–(12) will synchronize with the drive circuit described by Eqs. (5)–(9).

Reference [13] describes a technique for zeroing the phase difference ϕ_r in the receiver. The chaotic drive signal, x in this case, contains enough phase information that it may be used with a second order phase locked loop [25] to correct the response circuit phase. The drive signal input may be strobed with the response system output to create a series of voltages representing the value of the drive signal when the response output crossed zero. If the drive and response phases match, the response system output is the same as the drive signal, so the series of voltages are all zero. If the phases do not match, the

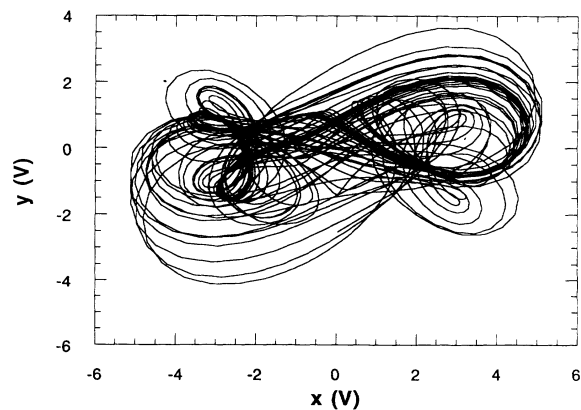

FIG. 1. Chaotic attractor from the circuit described by Eqs. (5)–(9).

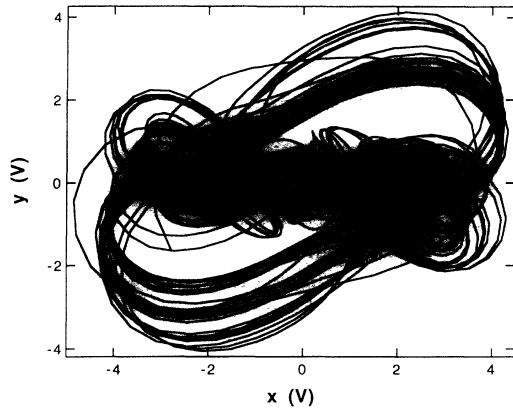

FIG. 2. Chaotic attractor from a numerical simulation of Eqs. (5)–(9).

response output will not be the same as the input, so some series of nonzero voltages is produced. This series of voltages is electronically sampled and integrated to produce a feedback signal which is proportional to the phase difference ϕ_r . The feedback signal is used to correct the periodic forcing frequency in the response system. A similar procedure was used to track a parameter value in an autonomous circuit [4]. The phase difference ϕ_r in the nonautonomous circuit may be thought of as just another parameter to be varied, so that this control scheme applies to autonomous and nonautonomous circuits.

IV. FILTERING AND SYNCHRONIZATION

The present work was motivated by problems in the synchronization of nonautonomous systems, but the concepts involved also apply to autonomous systems. There were two main problems that arose from the synchronization of nonautonomous systems that suggested the use of filtering in synchronization.

The first problem was that the chaotic drive signal sent from the drive system to the response system contained large peaks at the periodic forcing frequency and its harmonics. If these peaks could be suppressed, one could possibly communicate with a noise resistant broadband signal that looked essentially like background noise.

The second problem was the question of whether the synchronization of the two nonautonomous chaotic systems was really chaotic synchronization at all. The periodic component of the chaotic drive signal was large enough that it was possible that the phase matching technique was merely detecting the phase of a periodic signal, with the chaos being irrelevant. In order to determine whether the parameter matching technique did not depend on the periodic component of the chaotic drive signal, it was necessary to suppress this component completely.

A. Low pass filtering: simulations

In general, the drive signal is first transformed, and then the transformation is undone using the response sys-

tem and the fact that when the transformation is properly undone, the drive and response systems are in synchronization. In order to illustrate how this technique works, it is easier to start with a simple numerical example using a first order low pass filter. This filter is made by passing the drive system output signal x through a high pass filter (a model of a simple RC filter) and then subtracting the filter output, which contains the output signal high frequencies, from the output signal. This difference signal is then transmitted to the response system as the transmitted signal x_t , which contains the output signal low frequencies. At the response system, the response system output is filtered with an identical high pass filter, producing a signal v which contains the response signal high frequencies. This signal v is then added to the transmitted signal x_t , producing a reconstructed drive signal x_d , which is used as an input to the response system, completing a feedback loop in the response system. This scheme is shown in block diagram form in Fig. 3. The filters do produce phase shifts in the signals, but if the filters are matched, the phase shifts in the drive and response systems should match.

This system may be described by adding filter equations to Eqs. (5)–(12). The set of equations for this new synchronizing system is

$$\frac{dx}{dt} = \beta(y - z), \quad (13)$$

$$\frac{dy}{dt} = \beta[-\Gamma_y y - g(x) + \alpha \cos(\omega t) + A], \quad (14)$$

$$\frac{dz}{dt} = \beta[f(x) - \Gamma_z z], \quad (15)$$

$$\frac{du}{dt} = \frac{dx}{dt} - \frac{u}{RC}, \quad (16)$$

$$x_t = x - u, \quad (17)$$

$$\frac{dv}{dt} = \frac{dx''}{dt} - \frac{v}{RC}, \quad (18)$$

$$x_d = x_t + v, \quad (19)$$

$$\frac{dz'}{dt} = \beta[f(x_d) - \Gamma_z z'], \quad (20)$$

$$\frac{dx''}{dt} = \beta(y'' - z'), \quad (21)$$

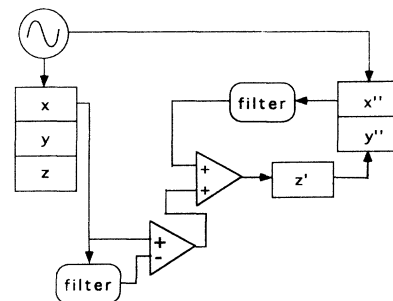

FIG. 3. Block diagram of filtering and reconstruction scheme for synchronization.

$$\frac{dy''}{dt} = \beta[-\Gamma_y y'' - g(x'') + \alpha \cos(\omega_r t + \phi_r) + A], \quad (22)$$

where all the parameters except R and C are the same as in Eqs. (5)–(12). The parameter C is set at 10^{-8} F, while the parameter R is chosen to set the break frequency of the filter (the point where the filter output is down 3 dB from its maximum). Equations (16) and (18) represent the high pass filters.

The new drive system of Eqs. (13)–(17) and the new response system of Eqs. (18)–(22) are no longer identical. The synchronization of nonidentical chaotic systems has been studied before [26] but synchronization in this case meant that the outputs of the systems were merely related to each other, not identical. In the examples presented here, synchronization is defined by the signals in the response system converging asymptotically to the corresponding signals in the drive system. The drive and response systems are effectively identical when they are synchronized; the question is whether or not this synchronized state is stable. There is other recent work that demonstrates that it is possible to construct a response system that will synchronize to a given signal [27], so a response system that is identical to the drive system is not a requirement for synchronization.

A low pass filter as described above might be useful if it was necessary to limit the bandwidth of a chaotic signal. Figure 4 shows the power spectrum of the drive signal x and the transmitted signal x_t , when the arrangement of Eqs. (13)–(22) is used with a value of $R = 31\,380 \, \Omega$. The breakpoint for the high pass filter of Eqs. (16) and (18) is 500 Hz for this value of R . The transmitted signal x_t contains fewer higher frequencies than x , as can be seen

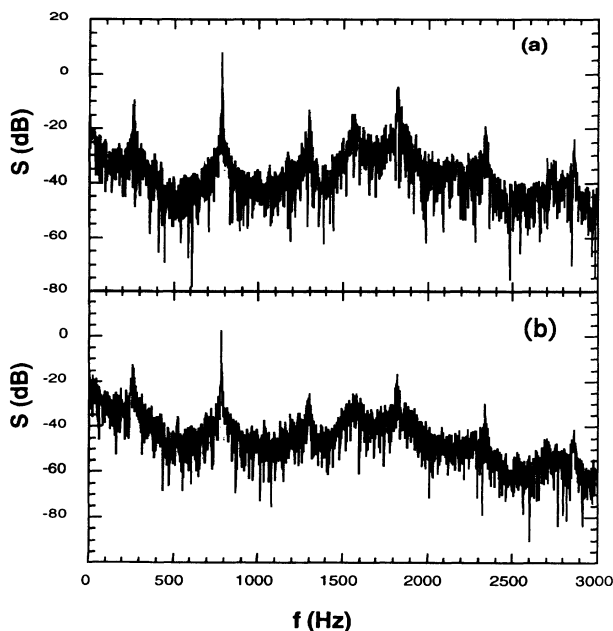

FIG. 4. (a) Power spectrum of x signal from numerical simulations of Eqs. (5)–(9). (b) Power spectrum of x_t signal (low pass filtered version of x) from numerical simulations of Eqs. (13)–(22).

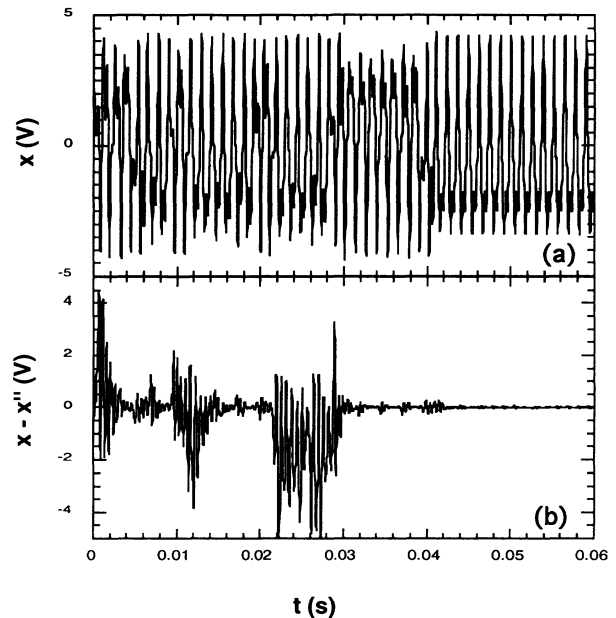

FIG. 5. (a) Time series of x from numerical simulations of Eqs. (13)–(22). (b) Difference δ between x and x'' in numerical simulations of Eqs. (13)–(22), showing approach to synchronization.

from Fig. 4. An important question is whether the response system of Eqs. (18)–(22) is stable in the synchronized state. A Lyapunov exponent calculation from the equations shows that the largest Lyapunov exponent in the response system is -319 s^{-1} , indicating that the response system is stable. Without the filter, the largest Lyapunov exponent for the response system was -780 s^{-1} , so the addition of the filtering to the dynamical system has made the response system less stable. It is possible that there are stable states that are not synchronized, but none were observed in this work.

The approach to synchronization is shown in Fig. 5. Figure 5(a) is a time series of the x variable, while Fig. 5(b) is the difference between x and x'' . The difference does not decrease smoothly, but rather shows some bursts caused by local instabilities in the response circuit. Although the global Lyapunov exponents for the response system are all less than zero, there may be places in phase space where one of the local exponents is greater than zero.

B. Band-stop filtering: experiment

In a periodically forced chaotic system such as that of Eqs. (5)–(9), band-stop filtering has some practical interest. As the unfiltered spectrum in Fig. 4 shows, the normal driving signal x for this system contains a large periodic component. Transmitting this periodic component uses a large amount of power and produces an easily recognizable feature in the power spectrum. In addition, transmitting a signal without the periodic component would be a useful test of the phase locking technique of [13]. In that work, the large periodic component

in the transmitted drive signal made it impossible to determine whether phase locking was simply due to the filtering of the large periodic component of the transmitted signal, or really was a case of parameter detection and tracking as in [4]. If the phases of the periodic forcing parts of two circuits could be matched when the periodic component of the driving signal was suppressed, this would prove that the nonperiodic components of the driving signal still carried information about the phase of the forcing part.

The band-stop filter arrangement uses the same arrangement as the low pass filtered described above; the signal x is first passed through a second order bandpass filter [25] and the filter output is then subtracted from the x signal to produce a transmitted signal with a particular band of frequencies suppressed. Five bandpass filters were used in parallel, one at the driving frequency of 780 Hz and one at each of the first four harmonics. It was also noted that the periodic part of the x signal was almost identical to the periodic forcing signal, so the forcing signal was subtracted from the x signal before filtering to further attenuate the component of the x signal at the forcing frequency. The equations of the bandpass filter were

$$w = \frac{d[x - \alpha \cos(\omega t)]}{dt}, \tag{23}$$

$$\frac{du_i}{dt} = \frac{-2.0}{R_{i2}C} u_i - \frac{1}{R_{i2}C} \left[\frac{1}{R_{i3}C} + \frac{1}{R_{i1}C} \right] v_i - \frac{1}{R_{i1}C} w, \tag{24}$$

$$\frac{dv_i}{dt} = u_i, \tag{25}$$

$$x_t = x + \sum_{i=1}^5 v_i, \tag{26}$$

$$x_d = x_t - \sum_{i=1}^5 r_i, \tag{27}$$

$$\frac{dq_i}{dt} = \frac{-2.0}{R_{i2}C} q_i - \frac{1}{R_{i2}C} \left[\frac{1}{R_{i3}C} + \frac{1}{R_{i1}C} \right] r_i - \frac{1}{R_{i1}C} \frac{dx''}{dt}, \tag{28}$$

$$\frac{dr_i}{dt} = q_i, \tag{29}$$

where x is the same as in Eq. (13), and x_d is used to drive the response system as in Eq. (20). The variables R_{ij} are defined for each of the bandpass filters in Table I. The

TABLE I. Resistor values for bandpass filters.

Center frequency (Hz)	R_1 (Ω)	R_2 (Ω)	R_3 (Ω)
780	204 000	408 000	1026
1560	102 000	204 000	513
2340	68 000	136 000	342
3120	51 000	102 000	256
3900	40 800	82 000	205

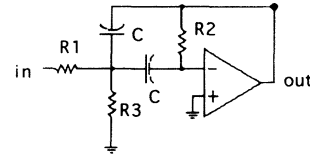

FIG. 6. Schematic of single bandpass filtered used to suppress periodic components of x signal. Resistor values are given in Table I.

actual resistor values were tuned with 20 turn potentiometers to adjust for errors in the capacitors. The value of C was 10^{-8} F. Figure 6 is a schematic of one of the bandpass filters. The Q factor for each bandpass filter was 20.

Figure 7(a) shows the power spectrum of the output signal x from the circuit. Figure 7(b) shows the power spectrum of the filtered signal [x_t in Eq. (26)] that is transmitted from the drive circuit to the response circuit. The periodic component at the forcing frequency has been attenuated by about 40 dB. The remaining periodic component at this frequency is far too small to affect the error correction circuit used in [13]. The response circuit periodic forcing could be made to lock to a purely periodic signal, but the minimum amplitude of the periodic signal was about 0.3 V, much larger than the periodic component of x_t .

Synchronization of the drive and response circuits using the band-stop filters was not very good. The Lyapunov exponents for the filtered system were calculated from Eqs. (5)–(9) and (23)–(29). In order to keep the

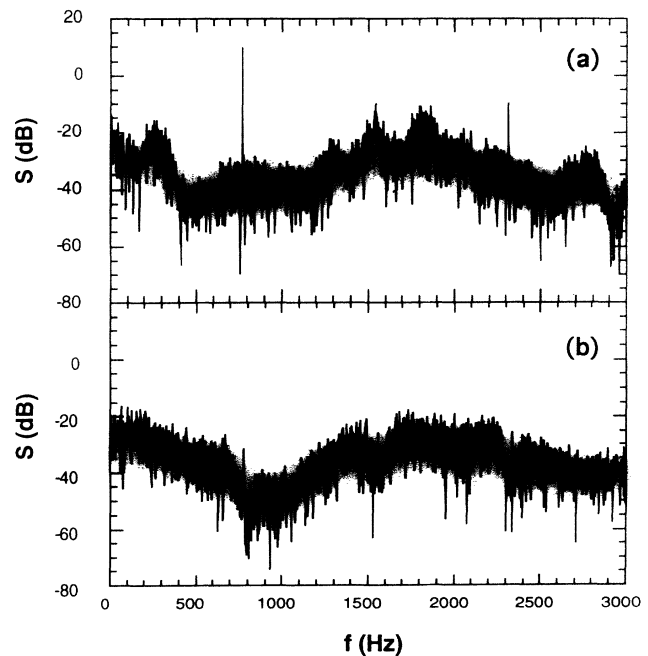

FIG. 7. (a) Power spectrum of the x signal from the circuit of Eqs. (5)–(9). (b) Power spectrum of the x_t signal from the circuit (band-stop filtered version of x).

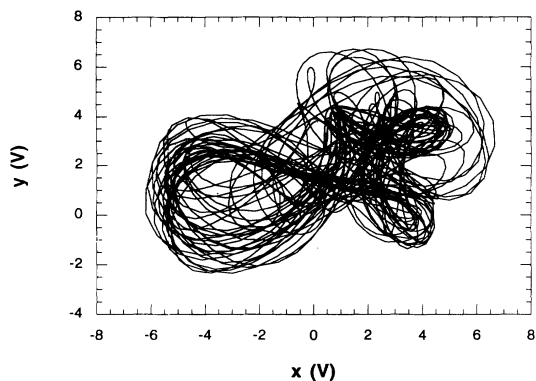

FIG. 8. Attractor from the circuit of Eqs. (5)–(9) when an offset of 1.0 V has been added to the periodic forcing.

number of variables manageable, only the filter at the fundamental frequency was used in the Lyapunov exponent calculations. The largest Lyapunov exponent for the response system was found to be -10 s^{-1} , which is much larger than the largest exponent for the unfiltered response system of -780 s^{-1} . With a global exponent so close to zero, the response circuit was very sensitive to local instabilities. It was possible to reduce the effect of the local instabilities by reducing the symmetry of the circuit attractor. Adding a 1.0-V offset to the drive signal [making A in Eq. (6) equal to 1.0] made the circuit spend less time in regions of local stability, improving the synchronization properties. The attractor for the circuit when A was equal to 1.0 is shown in Fig. 8. This attractor is simi-

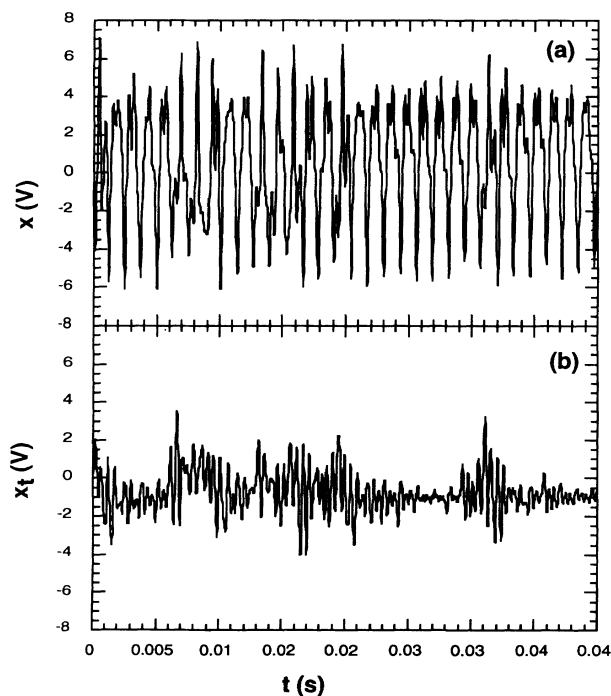

FIG. 9. (a) Time series of the x signal from the circuit of Eqs. (5)–(9). (b) Time series of the transmitted signal x_t from the circuit.

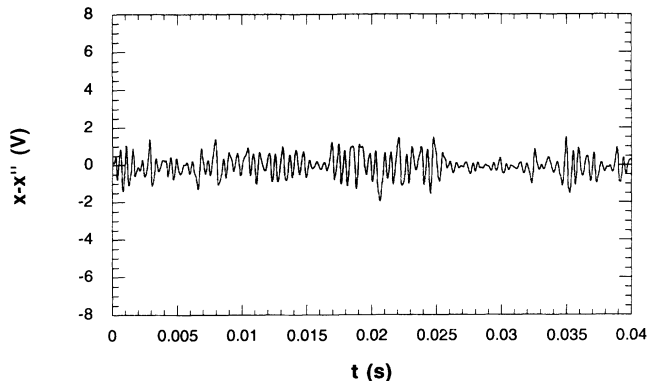

FIG. 10. Time series of the difference δ between x and x'' showing synchronization between two circuits when a band-stop filter is used.

lar to the original attractor of Fig. 1, but it has a lesser extent in the negative y direction. Most of the synchronization errors take place when y is near zero, so synchronization is improved because y spends less time near zero.

A time series of the x signal from the circuit is shown in Fig. 9(a), the transmitted signal x_t in Fig. 9(b), and the difference between x and x'' in Fig. 10. The difference signal in Fig. 10 shows much more bursting than when the simulated low pass filter was used. This is because the response system is much less stable and the real circuits are not perfectly matched. The synchronization, while not ideal, is still good enough to allow the phases of the periodic forcing of the drive and response to be matched.

V. PHASE SYNCHRONIZATION USING CHAOS

A previously described controller [13] was used to control the phase of the response circuit periodic forcing to match that of the drive circuit. The controller generated a series of voltages that corresponded to the value of the input signal x_d when the output signal x'' crossed zero. If the drive and response circuits were synchronized, these voltages would all be zero. An integrator with a time constant of 1 s averaged the series of voltages to produce an error signal Δ , which was used to vary the frequency of the response periodic forcing to zero the phase difference ϕ , between the drive and response periodic forcing. Figure 11 shows the periodic forcing F'' for the response versus the periodic forcing F for the drive. There is some fluctuation of the response phase and a constant phase offset which is an artifact of the control circuit, but the basic principle works. This demonstrates that the nonperiodic part of the chaotic signal carries information about the phase of the periodic part. Most of the phase fluctuation is believed to be caused by component mismatch between the two circuits. There is also a phase flip caused by a signal change in the filters.

The response circuit still has some noise resistance as in the unfiltered case. The noise resistance was tested with white noise, but this is an easy type of noise to overcome. The noise resistance was also tested by adding a

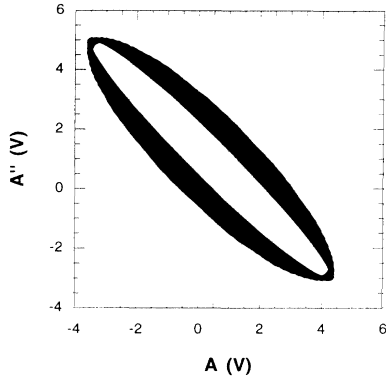

FIG. 11. Periodic forcing F'' for the response circuit vs periodic forcing F for the drive circuit when a band-stop filter is used.

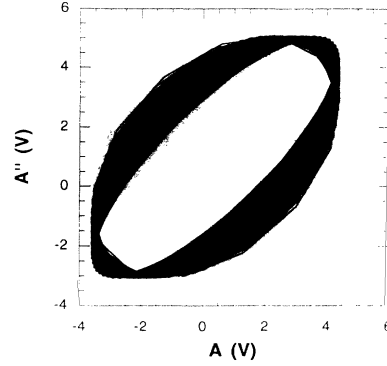

FIG. 13. Periodic forcing F'' for the response circuit vs periodic forcing F for the drive circuit when the response circuit is driven by the sum of x_t and another chaotic signal as seen in Fig. 12.

contaminating chaotic signal from another circuit [14] to the transmitted signal x_t at about twice the amplitude. Figure 12 is a power spectrum of the combined signal. Figure 13 shows the periodic forcing F'' for the response versus the periodic forcing F for the drive when the contaminating chaos has been added to the transmitted signal. The phase fluctuation has increased, but the phase of the response periodic part is still under control. The circuit that adds the contamination also adds another inversion to the transmitted signal x_t , so the phases in Fig. 13 are flipped relative to Fig. 11. Phase control in the presence of additive signals is still possible if the additive signal has zero mean when strobed with the response system output x'' . If the additive signal becomes too large, this condition can break down.

Synchronization of unfiltered periodically forced chaotic systems can be particularly difficult if the contaminating signal is from a system forced at the same frequency. The band-stop filtering minimizes this problem. As an example, another Duffing circuit with different parameters was built. This second Duffing circuit was described by the equations

$$\frac{d\xi}{dt} = 10^4 \psi, \tag{30}$$

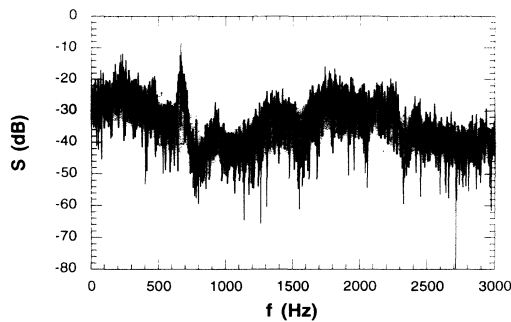

FIG. 12. Power spectrum of the sum of x_t and a signal from another chaotic circuit.

$$\frac{d\psi}{dt} = 10^4 [\beta \cos(\omega t + \phi_2) + A_2 - 0.256\psi - \xi^3], \tag{31}$$

where β was 6.20 V and A_2 was 0.5 V. This second Duffing circuit was forced with an independent periodic forcing source at 780 Hz, so the phase ϕ_2 was not the same as the phase of the periodic forcing for the drive circuit. The ξ signal was filtered with a band-stop filter to remove the forcing frequency and the first four harmonics and then added to the transmitted signal x_t with up to the same amplitude as x_t . Figure 14 is the power spectrum of the filtered ξ signal (the contaminating signal) from the second Duffing circuit. Synchronization of the periodic forcing in the drive and response systems was not lost when the filtered ξ signal was as large as the x_t signal. Synchronization was lost for larger amplitudes of the filtered ξ signal. The response circuit periodic forcing source would not synchronize to the periodic forcing source for the second Duffing circuit, demonstrating signal rejection when a similar but incorrect signal was present. Synchronization is possible because the non-periodic parts of the signal carry information about the forcing phase.

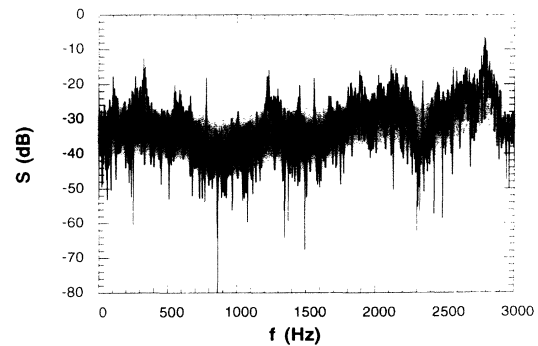

FIG. 14. Power spectrum of the filtered ξ signal from the circuit of Eqs. (30) and (31).

VI. CONCLUSIONS

It has been shown above that when the proper type of transformation is used, the driving signal for a synchronized chaotic system can be transformed and then reconstructed at the response system so that synchronization takes place. The transformation used here consists of passing the synchronizing signal through a filter and subtracting the filter output from the synchronizing signal to produce a transmitted signal. The reconstruction then involves a feedback loop where the output of the response system is filtered and the filter output is added to the transmitted signal to produce a reconstructed synchronizing signal to drive the response system. The reconstruction is not an inverse transformation, so problems such as having an ill-conditioned transformation do not occur.

The filtering is only one example of a more general type of transformation. In general, a transformation $T(x)$ is applied to the drive signal x . At the response system, the output x'' of the response system is used with the signal $T(x)$ to generate a signal x_d which then drives the response system: $x_d = G(T(x), x'')$. When the response system is synchronized to the drive system, the

response output x'' is equal to the driving signal for the response, x_d . In this case, $G(T(x), x'') = x''$. A trivial example would be that G is an identity with respect to x'' . This actually gives the original complete chaotic circuit, but this function would not be responsive to x , so synchronization would not take place, and no information could be transferred. An example where $T(x) = x$, and $G(x, x'') \neq x''$ has also been shown [28]. In a system described by Pyragas [20], $T(x) = x$ and $G(x, x'') = K\{x - x''\}$. Pyragas also does numerical calculations to find conditional Lyapunov exponents to demonstrate that the response system is stable for some ranges of K .

In the system described in the present work, $G(T(x), x'')$ is like a cascaded synchronizing system [4,14] (because the output is synchronized to the input) except that the part that depends on $T(x)$ is varying. The concepts described in this paper may be applied to autonomous as well as nonautonomous systems.

For synchronization to be observable, the synchronized state must be stable. This is a more complex problem than simply requiring the response system to be stable, for it is possible that some nonsynchronized state is stable. A simple application of this system to communications and signal separation will be shown elsewhere.

-
- [1] L. M. Pecora and T. L. Carroll, Phys. Rev. Lett. **64**, 821 (1990).
 - [2] L. M. Pecora and T. L. Carroll, Phys. Rev. A **44**, 2374 (1991).
 - [3] T. L. Carroll and L. M. Pecora, IEEE Trans. Circuits Syst. **38**, 453 (1991).
 - [4] T. L. Carroll and L. M. Pecora, Physica D **67**, 126 (1993).
 - [5] R. He and P. G. Vaidya, Phys. Rev. A **46**, 7387 (1992).
 - [6] N. Gupte and R. E. Amritkar, Phys. Rev. E **48**, 1620 (1993).
 - [7] A. R. Volkovskii and N. F. Rul'kov, Pis'ma Zh. Tekh. Fiz. **18**, 22 (1992) [Sov. Tech. Phys. Lett. **18**, 410 (1992)].
 - [8] M. d. S. Viera, A. J. Lichtenberg, and M. A. Lieberman, Phys. Rev. A **46**, 7359 (1992).
 - [9] K. M. Cuomo and A. V. Oppenheim, Phys. Rev. Lett. **71**, 65 (1993).
 - [10] L. O. Chua, L. Kocarev, K. Eckart, and M. Itoh, Int. J. Bifurc. Chaos **2**, 705 (1992).
 - [11] L. Kocarev, K. S. Halle, K. Eckert, L. O. Chua, and U. Parlitz, Int. J. Bifurc. Chaos **2**, 709 (1992).
 - [12] K. Murali and M. Lakshmanan, Phys. Rev. E **48**, 1624 (1993).
 - [13] T. L. Carroll and L. M. Pecora, IEEE Trans. Circuits Syst. **40**, 646 (1993).
 - [14] T. L. Carroll and L. M. Pecora, Int. J. Bifurc. Chaos **2**, 659 (1992).
 - [15] A. V. Oppenheim, G. W. Wornell, S. H. Isabelle, and K. M. Cuomo, in *Proceedings of the International Conference on Acoustics, Speech and Signal Processing*, edited by A. Oppenheim (IEEE, San Diego, 1992), Vol. 4, p. 117.
 - [16] R. H. Sherman and J. Gullicksen, in *Chaos in Communications*, edited by L. Pecora, SPIE Proc. Vol. 2038 (SPIE, Bellingham, WA, 1993), p. 141.
 - [17] U. Parlitz, L. O. Chua, L. Kocarev, K. S. Halle, and A. Shang, Int. J. Bifurc. Chaos **2**, 973 (1992).
 - [18] K. M. Cuomo, Int. J. Bifurc. Chaos **3**, 1327 (1993).
 - [19] K. M. Cuomo, A. V. Oppenheim, and S. H. Strogatz, IEEE Trans. Circuits Syst. **40**, 626 (1993).
 - [20] K. Pyragas, Phys. Lett. A **181**, 203 (1993).
 - [21] T. L. Carroll and L. M. Pecora, Phys. Rev. E **48**, 2426 (1993).
 - [22] D. H. Sheingold, *Nonlinear Circuits Handbook* (Analog Devices, Norwood, MA, 1976).
 - [23] C. L. Johnson, *Analog Computer Techniques* (McGraw-Hill, New York, 1963).
 - [24] J. Eckmann and D. Ruelle, Rev. Mod. Phys. **57**, 617 (1985).
 - [25] U. Tietze and C. Shenk, *Electronic Circuits* (Springer, Berlin, 1991).
 - [26] N. F. Rulkov, A. R. Volkovski, A. Rodriguez-Lozano, E. D. Rio, and M. G. Velarde, Int. J. Bifurc. Chaos **2**, 669 (1992).
 - [27] R. Brown (unpublished).
 - [28] V. S. Anishchenko, T. E. Vadivosa, D. E. Postnov, and M. A. Safonova, Int. J. Bifurc. Chaos **2**, 633 (1992).